

## QUANTUM

### Versiune

Quantum

### Colectie

Cooking systems

### Cod EAN

8034122359762



Fotografie cu caracter strict orientativ  
Aceasta poate sa nu corespunda versiunii selectate

## CARACTERISTICI

**Indicator de caldura reziduala**  
**Functia de mentinere a caldurii:**  
**maxim 70 gr.C**  
**9 Trepte de putere pentru gatit**  
**+ functie Boost**  
**Senzor de detectie a vasului**  
**Timer / Alarma**  
**Functii de siguranta**  
**Oprit/Blocat**  
**Punte dubla pentru vase de**  
**gatit cu diverse forme**  
**Timer automat pentru oprire**  
**Sistem de management al**  
**puterii pe 3 trepte: 2.8 kW, 3.5**  
**kW, 7.4 kW**  
**Motor Brushless**  
**Control tactil cu LED cu display**  
**cu LED-uri rosii integrate in**  
**sticla**  
**Avertizare incarcare filtru**  
**metalic**  
**Avertizare incarcare filtru**  
**Carbon.Zeo**  
**Schott black ceramic glass**  
**Black steel extraction area**  
**frame**  
**Auto mode (suction speed**  
**automatically adjusts to**  
**cooking power)**  
**4 cooking areas with Flex**  
**Surface technology**

## ACCESORII OPTIONALE

### KACL.930

Filtru Carbon.Zeo Mic

### KACL.931

Filtre Carbon.Zeo - De rezerva

### KACL.951

Underbase Slim filter unit  
(h60mm)

### KACL.952

Filter replacement (underbase  
Slim filter unit - h60mm)

### KACL.955

Base grid (underbase Slim filter  
unit - h60mm)

## CARACTERISTICI TEHNICE

**Tip de instalare**  
De blat  
**Dimensiuni**  
84 cm  
**Finisaj**  
Sticla neagra Schott  
**Motor**  
600 m<sup>3</sup>/h  
**Tipul panoului de control**  
Touch control  
**Setari de viteza**  
9

## AMBALARE: GREUTATE SI VOLUM

### Greutate bruta

34 kg

### Greutate neta

27.9 kg

### Volum

0.24 m<sup>3</sup>

### Dimensiuni ambalaj

Lungime

1055 mm

Inaltime

375 mm

Adancime

610 mm

## CARACTERISTICI CONSUM SI CONEXIUNE

### Consum maxim

7560 W

### Curent

220-240V

### Frecventa

50-60Hz

### CLASA DE ENERGIE

A+

## QUANTUM

### Versiune

Quantum

### Colectie

Cooking systems

### Cod EAN

8034122359762

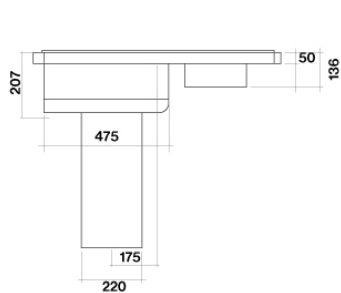

front view

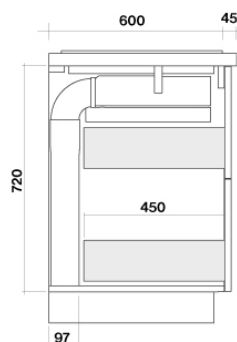
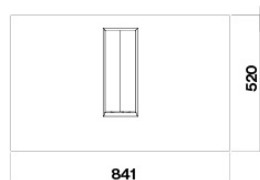

installation on a 60 cm top

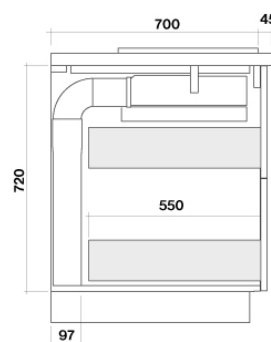

installation on a 70 cm top

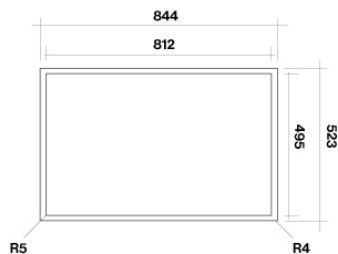

flush installation

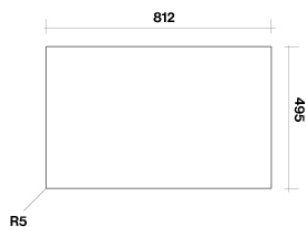

over top installation

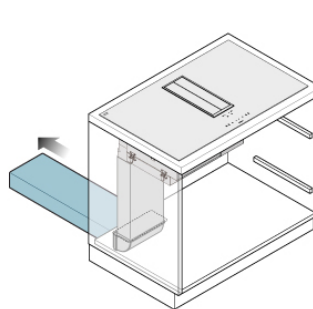

ducted version

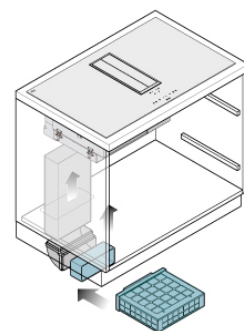

recirculating version KACL.930

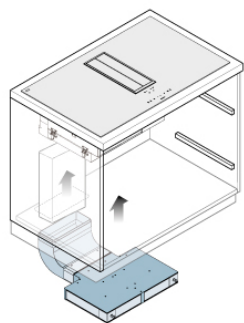

recirculating version KACL.951

## QUANTUM

### Versiune

Quantum

### Colectie

Cooking systems

### Cod EAN

8034122359762

## ETICHETA DE ENERGIE

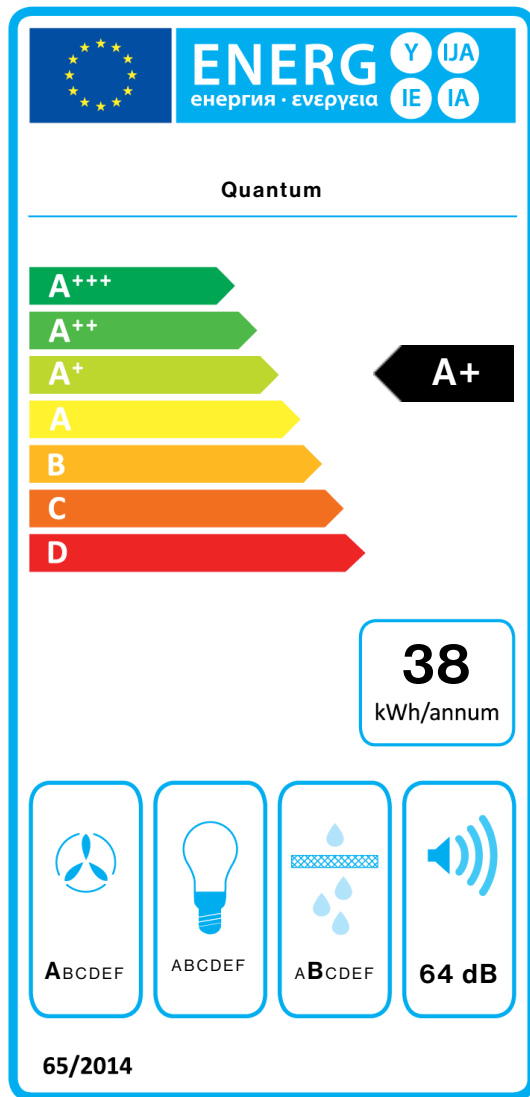

PF		
S	Falmec Spa	
M	Quantum	
AEC	38,3	kWh/a
EEC	A+	
FDE	33,1	
FDEC	A	
LE	0,0	
LEC		
GFE	87,0	
GFEC	B	
Qmin	170,0	m <sup>3</sup> /h
Qmax	390,0	m <sup>3</sup> /h
Qboost	495,0	m <sup>3</sup> /h
SPEmin	46	dBa
SPEmax	64	dBa
SPEboost	69	dBa
PO	-	W
PS	0,48	W
PI		
F	0.8	
EEl	43,8	
Qbep	267,0	m <sup>3</sup> /h
Pbep	584	Pa
Qboost	495,0	m <sup>3</sup> /h
Wbep	131,0	W
WL	0,00	W
Emiddle	0	lex
Lwa-SPEmax	64	dBa